



## Walkia Octagona

### Teknisk information

| Effekt | Mått och vikt         | 150 lm/W | 160 lm/W | 170 lm/W | 190 lm/W |
|--------|-----------------------|----------|----------|----------|----------|
| 60W    | 262x261x118mm - 2.3kg | 9000 lm  | 9600 lm  | 10200 lm | 11400 lm |
| 80W    | 261x261x172mm - 2.9kg | 12000 lm | 12800 lm | 13600 lm | 15200 lm |
| 100W   | 261x261x172mm - 2.9kg | 15000 lm | 16000 lm | 17000 lm | 19000 lm |
| 120W   | 300x300x190mm - 3.9kg | 18000 lm | 19200 lm | 20400 lm | 22800 lm |
| 150W   | 300x300x190mm - 3.9kg | 22500 lm | 24000 lm | 25500 lm | 28500 lm |
| 160W   | 300x300x190mm - 3.9kg | 24000 lm | 25600 lm | 27200 lm | 30400 lm |
| 200W   | 300x300x201mm - 5.7kg | 30000 lm | 32000 lm | 34000 lm | 38000 lm |
| 240W   | 300x300x201mm - 5.7kg | 36000 lm | 38400 lm | 40800 lm | 45600 lm |

Samtliga värden + 25 C vid omgivande temperatur, 4 000 K, +5 % tolerans i ljusflödet, + -5 %

|   |  |
|---|--|
| <b>Ljusstyrka</b>                               | 150/160/170/190 lm/W                   |
| <b>Färgtemperatur</b>                           | 4000K, 5000K, 5700K                    |
| <b>Optik</b>                                    | Genomsiktig lin                        |
| <b>Kontroll</b>                                 | ON/OFF, 1-10V, DALI, Walkia Vantage    |
| <b>Genomsnittlig livstid (L90B10/ Ta 25 °C)</b> | 100 000 h                              |
| <b>Integrerad rörelsesensor</b>                 | Nej                                    |
| <b>Flimmerfri</b>                               | Alternativ                             |
| <b>Anslutning</b>                               | Anslut kontakten / kontakten / uttaget |
| <b>Energieffektivitetsklass</b>                 | A++                                    |
| <b>Ingångsspänning</b>                          | AC100~277V 50/60HZ                     |
| <b>Effekt factor</b>                            | >0,95                                  |
| <b>THD</b>                                      | <20%                                   |
| <b>Färgåtergivningindex / CRI</b>               | >80 / 90 / 95 (Alternativ)             |
| <b>Strålens öppningsvinkel</b>                  | 60°, 90° & 120°                        |
| <b>Driftstemperatur</b>                         | -40 °C ~ +40 °C                        |
| <b>Höjljets material</b>                        | Aluminium, PCB & PC                    |
| <b>Kapslingsklass</b>                           | IP65                                   |
| <b>Garanti</b>                                  | 5 år                                   |
| <b>Certifieringar</b>                           | CE, ROHS                               |
| <b>Strömförsörjning</b>                         | Meanwell                               |
| <b>LED-ledtillverkare</b>                       | Nichia                                 |
| <b>Montering</b>                                | Hängande, väggfäste, stolpmontering    |
| <b>Överhettningsskydd</b>                       | Ja, med automatisk återgång (85° C)    |
| <b>Korrosion, smuts och dammskydd</b>           | Ja                                     |

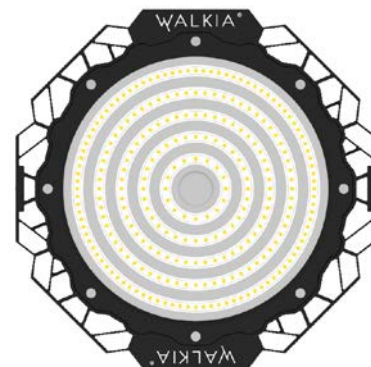

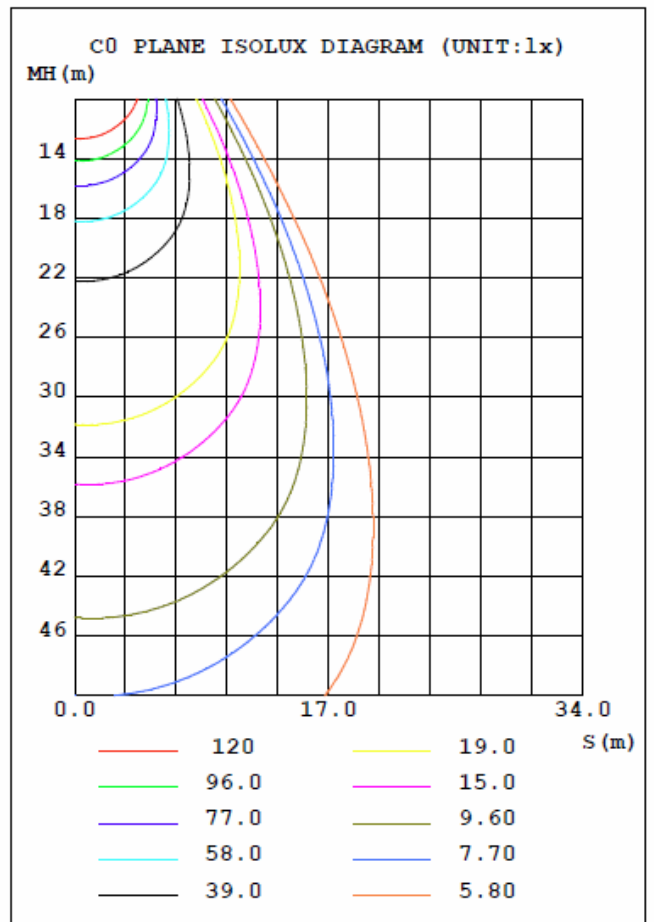
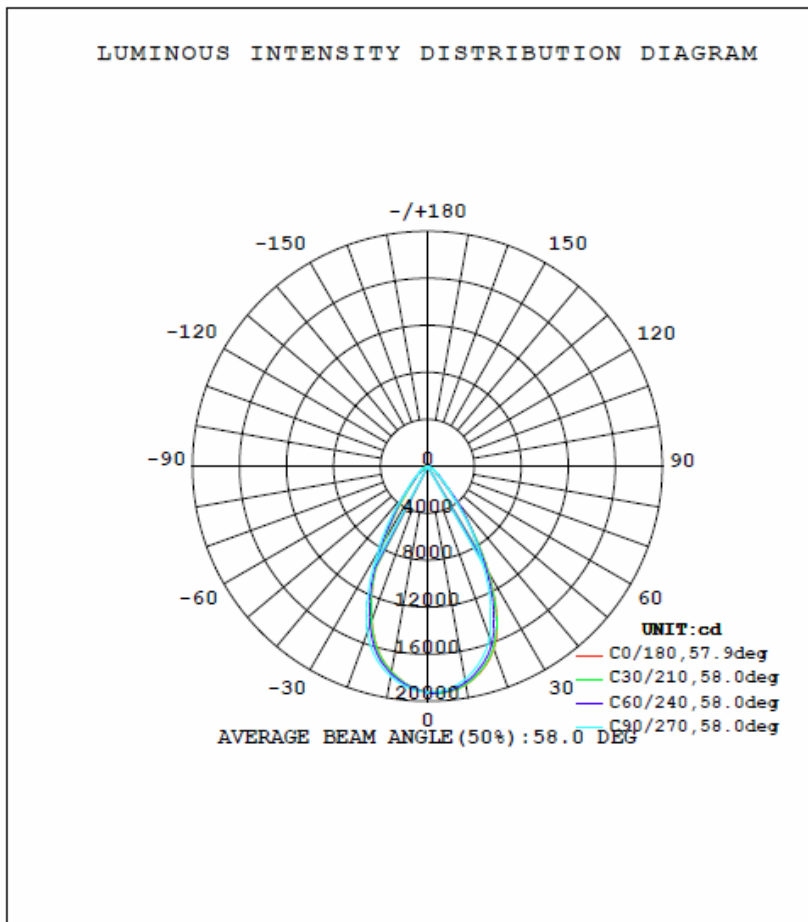

Walkia Octagona - Mått

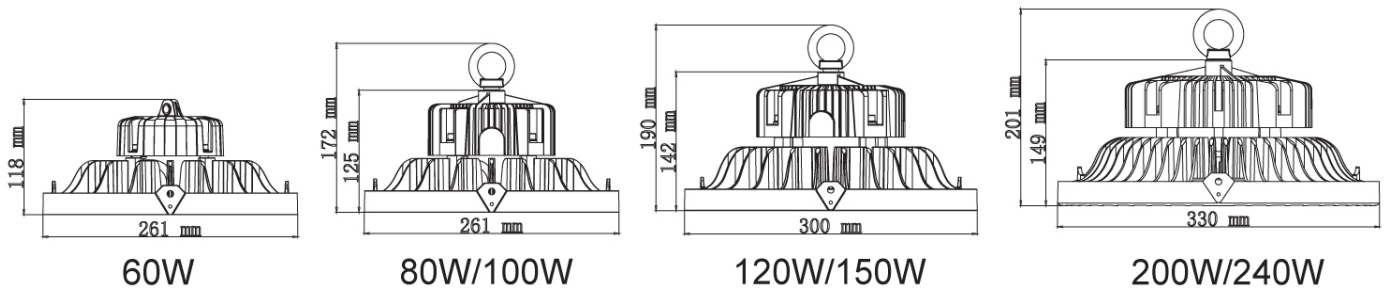

|      | L * W * H (mm) | NW (kg) | GW (kg) |
|------|----------------|---------|---------|
| 60W  | 261*261*118    | 2.3     | 3.1     |
| 80W  | 261*261*172    | 2.9     | 3.7     |
| 100W |                |         |         |
| 120W | 300*300*190    | 3.9     | 4.9     |
| 150W |                |         |         |
| 200W | 330*330*201    | 5.7     | 6.8     |
| 240W |                |         |         |

## Ledningar

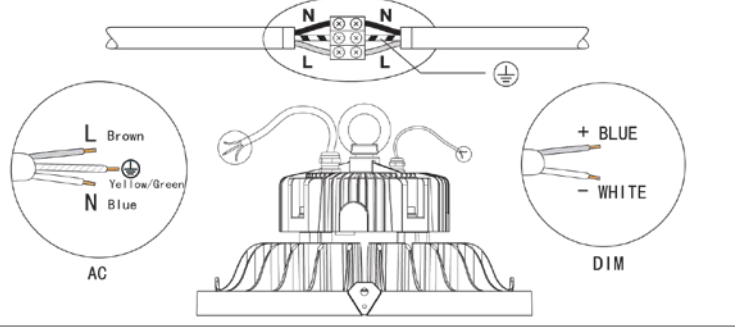

## Takmontering

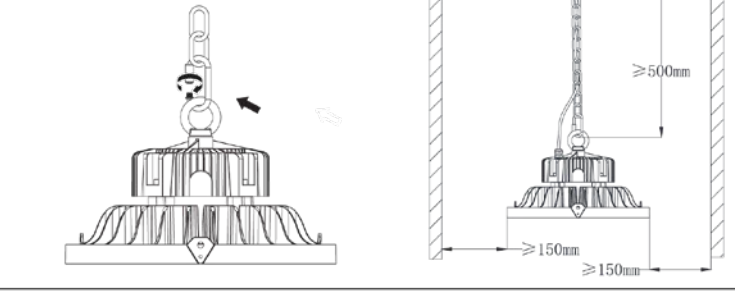

2

## Polmontering

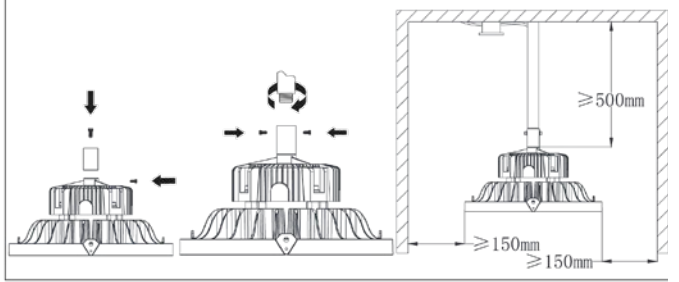

## Väggmontering

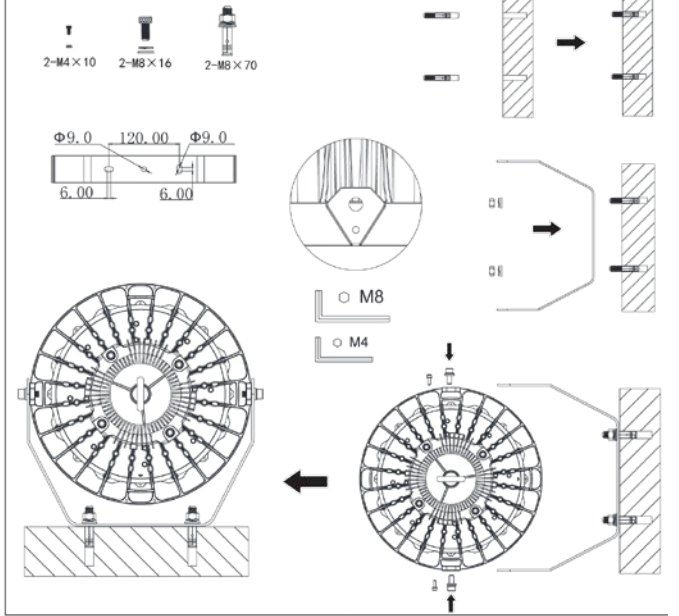

3

